

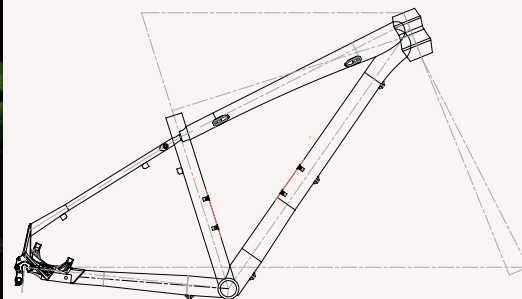

Adlerwerke GmbH **2019**







MODELL ADLER Evo 3 Junior / 27,5" / 381mm

- RAHMEN Alloy HYDROFORMED D.B.
- GABEL RockShox 30 Silver / 100mm TurnKey Lockout
- STEUERSATZ Neco H148M
- LENKER CONTROL TEC ATB
- GRIFFE VELO VLG
- KURBELGARNITUR SRAM FC S600 3.0 POWER SPLINE
- KASSETTE SRAM PG 950 MTB / 11-34
- KETTE SRAM PC 951 mit Power Link
- SCHALTWERK FD X4 3x9 / RD X5 CAGE BLK
- BREMSANLAGE Scheibenbremse DB - DB1
- LAUFRADSATZ MAXXIS IKON 27,5 2.2
- REIFEN MAXXIS 27,5 x 1.9 / 2.35
- SATTEL Pulse

Technical Features



irs inner cable routing



rlo remote lockout



lht Lapierre head tube



dts dynamic tube shaping



ipm inner post mount



ubf ultra-lite alloy frame



AW
ADLER Werke

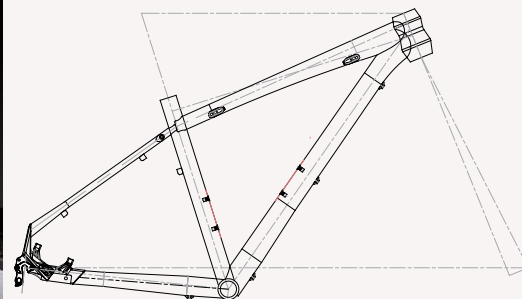

MODELL ADLER Evo 3 Dame / 27,5" / 432mm

- RAHMEN Alloy HYDROFORMED D.B.
- GABEL RockShox 30 Silver / 100mm TurnKey Lockout
- STEUERSATZ Neco H148M
- LENKER CONTROL TEC ATB
- GRIFFE VELO VLG
- KURBELGARNITUR SRAM FC S600 3.0 POWER SPLINE
- KASSETTE SRAM PG 950 MTB / 11-34
- KETTE SRAM PC 951 mit Power Link
- SCHALTWERK FD X4 3x9 / RD X5 CAGE BLK
- BREMSANLAGE Scheibenbremse DB - DB1
- LAUFRADSATZ MAXXIS IKON 27,5 2.2
- REIFEN MAXXIS 27,5 x 1.9 / 2.35
- SATTEL Pulse

Technical Features





AW
ADLERWERKE

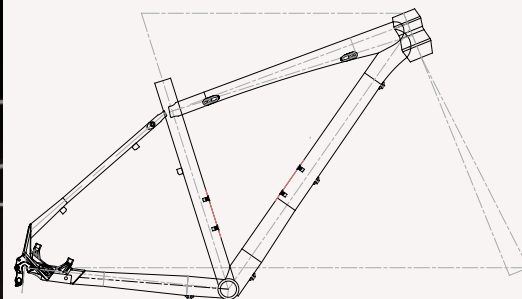

MODELL ADLER Evo 3 - 29" / 483mm / 508mm

- RAHMEN Alloy HYDROFORMED D.B.
- GABEL RockShox 30 Silver / 100mm TurnKey Lockout
- STEUERSATZ Neco H148M
- LENKER CONTROL TEC ATB
- GRIFFE VELO VLG
- KURBELGARNITUR SRAM FC S600 3.0 POWER SPLINE
- KASSETTE SRAM PG 950 MTB / 11-34
- KETTE SRAM PC 951 mit Power Link
- SCHALTWERK FD X4 3x9 / RD X5 CAGE BLK
- BREMSANLAGE Scheibenbremse DB - DB1
- LAUFRADSATZ MAXXIS IKON 27,5 2.2
- REIFEN MAXXIS 27,5 x 1.9 / 2.35
- SATTEL Pulse

Technical Features



irs inner cable routing



rlo remote lockout



lht Lapierre head tube



dts dynamic tube shaping



ipm inner post mount



ubf ultraLite alloy frame



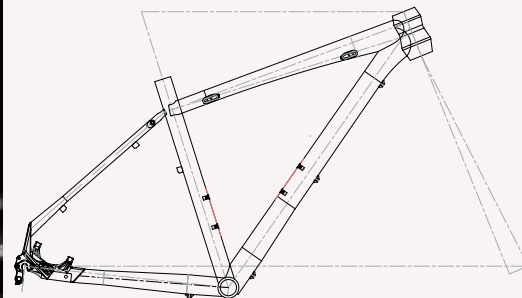

MODELL ADLER Evo 4 - 27,5" / 29"
381mm / 432mm / 483mm / 508mm

- RAHMEN Alloy HYDROFORMED D.B.
- GABEL RockShox Recon Silver RL / 100mm / Motion Control
- STEUERSATZ Neco H148M
- LENKER CONTROL TEC ATB
- GRIFFE VELO VLG
- KURBELGARNITUR SRAM FC X5
- KASSETTE SRAM CS-PG 1030 / 11-36 T
- KETTE SRAM PC 1031 mit Power Link
- SCHALTWERK FD X5 2x10 / RD X5 105 CAGE BLK
- BREMSANLAGE Scheibenbremse DB - DB5
- LAUFRADSATZ MAXXIS IKON 27,5 / 29 2.2
- REIFEN MAXXIS 27,5 / 29 x 1.9 / 2.35
- SATTEL Pulse

Technical Features



irs inner cable routing



rlo remote lockout



lht Lapierre head tube



dts dynamic tube shaping



ipm inner post mount



uaf ultralite alloy frame



AW
ADLERWERKE

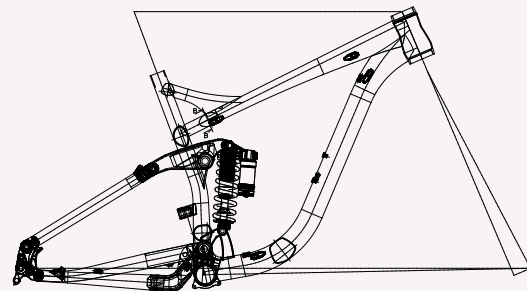

• MODELL ADLER Evo FR / 27,5"

- RAHMEN Alloy HYDROFORMED D.B.
- GABEL RockShox Sektor Gold RL 27,5" / 150mm
- DÄMPFER RockShox MONARCH RL 200x57 430LB LOCKOUT
- LENKER CONTROL TEC HB CLS 750mm
- GRIFFE VELO VLG
- KURBELGARNITUR SRAM FC S1000 24mm
- KASSETTE SRAM CS - PG 1030 / 11 - 36
- KETTE SRAM PC 1031 mit Power Link
- SCHALTWERK FD GX HD 2x10 / RD GX 10SPD TYPE 2.1
- BREMSANLAGE Scheibenbremse DB - DB5
- LAUFRADSATZ MAXXIS HR II 2.3 TR
- REIFEN MAXXIS 27,5 x 1.9 / 2.35
- SATTEL Pulse

Technical Features



irs inner cable routing



rlo remote lockout



lht Lapierre head tube



dts dynamic tube shaping



ipm inner post mount



uaf ultra-lite alloy frame



AW
ADLERWERKE

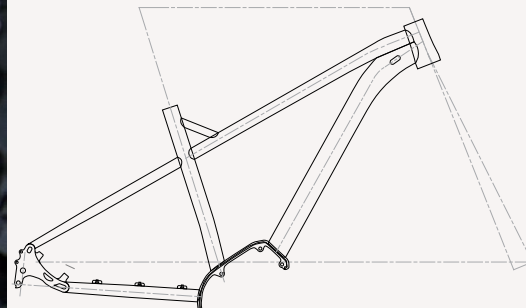

MODELL ADLER Evo EXC - 27,5" +
440mm / 480mm / 510mm

- RAHMEN Alloy HYDROFORMED D.B.
- GABEL RockShox JUDY Gold RL 27.5" / 120mm / Solo Air
- STEUERSATZ Neco H156CBK1BKM
- LENKER CONTROL TEC ATB-213DB6-8
- GRIFFE VELO VLG- 975-11D2
- KURBELGARNITUR Shimano FC-E8000, 175mm
- KASSETTE Shimano CS-HG500-10 / 10 speed
- KETTE KMC X10eS NPBK (Sport)
- SCHALTWERK RD-M6000, Deore, GS 10 sp., SHADOW +
- BREMSANLAGE Shimano Deore, BL-M6000
- LAUFRADSATZ WTB Ranger 2.8 TCS Tough/Fast Rolling
- REIFEN WTB W115-0070
- SATTEL WTB Volt W165-2783

Technical Features



irs inner cable routing



rlo remote lockout



lht Lapera head tube



dts dynamic tube stepping



ipm inner post mount



uaf ultrafine alloy frame



AW
ADLERWERKE

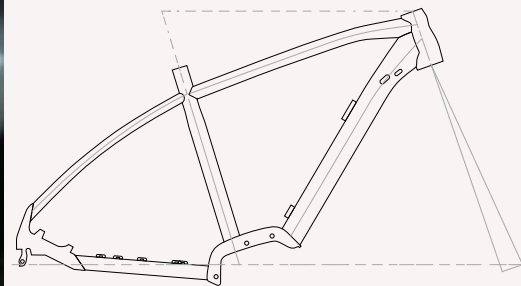

• **MODELL ADLER Evo EM / 700C**

- **RAHMEN** Alloy HYDROFORMED D.B.
- **GABEL** RockShox PARAGON Silver TK QR / COIL 50mm
- **LENKER** CONTROLTEC HB CLS 750mm
- **GRIFFE** VELO VLG
- **KURBELGARNITUR** Shimano, e-steps / FC-E6000, 175mm
- **KASSETTE** Shimano CS-HG50-10, 10-speed
- **KETTE** KMC / X10eS NPBK (Sport)
- **SCHALTWERK** RD-M610, DEORE, 10-sp. / SHADOW Design
- **BREMSANLAGE** Shimano Disc Brake BL-M396L
- **LAUFRADSATZ** MAXXIS 700 X42C M2016P DK62 KI Wire
- **REIFEN** MAXXIS 700 X35 /43C FV THIN
- **SATTEL** VELO VL-3586

Technical Features



irs inner cable routing



rlo remote lockout



lht Lapierre head tube



dls dynamic tube shaping



ipm inner post mount



ubf ultra-lite alloy frame



AW
ADLERWERKE



In 2016 the oldest German bicycles brand will have its 135th Anniversary.

For this occasion a team of engineers, designers, and fans of the brand decided to revive the production and traditions of the legendary ADLER Fahrrad, which has been renowned around the world with its numerous innovations, original technical solutions and aesthetics.



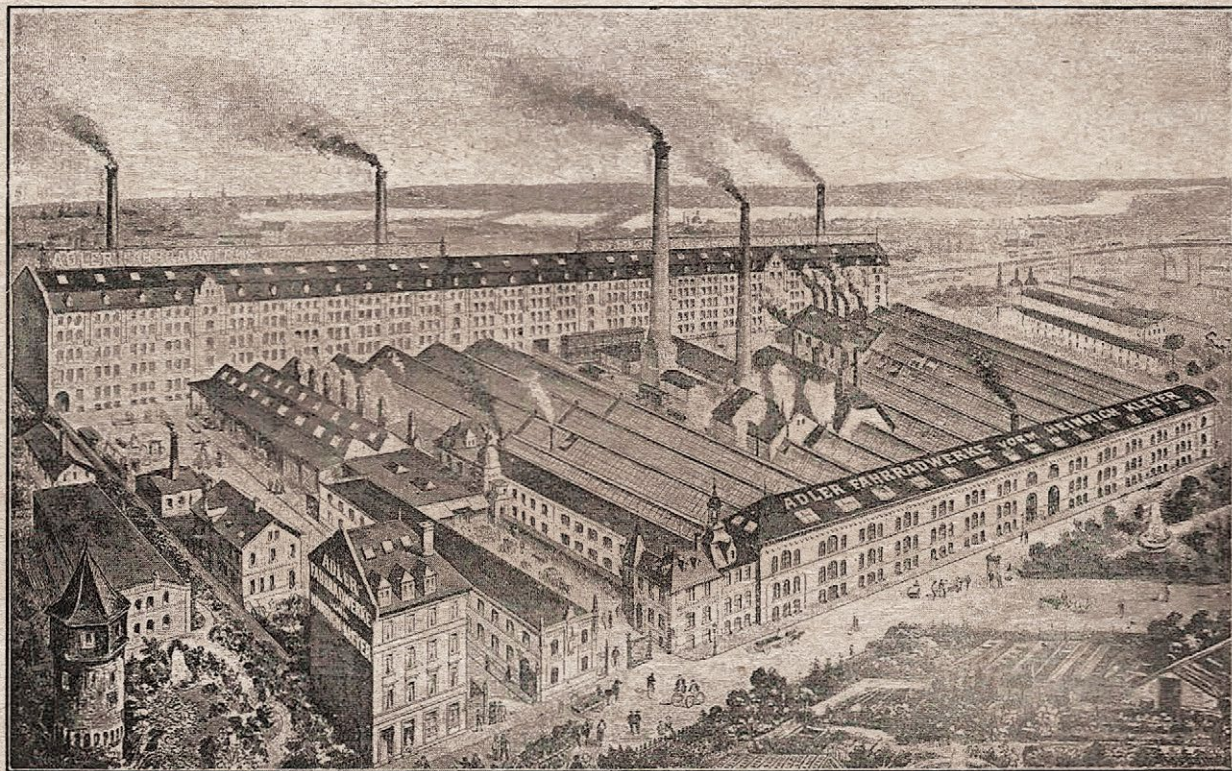

Adler Fahrradwerke vorm. Heinrich Kleyer, Frankfurt a. M.

Adlerwerke GmbH

Pelikanstraße 52

70378 Stuttgart

Deutschland



www.adlerbikes.de